



# Instruction Manual

**INNOCENTI**

SOC. GENERALE PER L'INDUSTRIA METALLURGICA E MECCANICA  
NEW YORK - MILANO - FABRIANO

**Lambretta 150 15**

**INNOCENTI**

SOC. GENERALE PER L'INDUSTRIA METALLURGICA E MECCANICA

DIVISIONE MOTORI

*We are honoured and pleased to welcome you amongst the owners of a Lambretta 150 li, and appreciate your choice in our product. The Lambretta 150 li was designed and built in our works and has reached you after exacting checks and tests, thus ensuring the perfection and warranty of our product.*

*The life of your scooter depends very much on the use and maintenance you give it. We have here, briefly summarized some fundamental hints and instructions which we feel will help you in knowing and making the most of your new machine.*

*Remember we have created in this country and throughout Europe a network of authorised Lambretta Service dealers, with trained personnel and fully equipped with tools and original spare parts to ensure the perfect functioning of your machine. Do not hesitate to take advantage of their skill and expert knowledge at any time. We wish you « Bon voyage » on your new Lambretta 150 li, designed for you, the connoisseur.*



## CONTENTS

Identification of the scooter . . . . .	Page	3
Keys . . . . .	»	4
Controls . . . . .	»	5
<b>SERVICE INSTRUCTIONS</b>		
During running-in period . . . . .	»	8
Fuel - Fuel tank . . . . .	»	8
Wheels . . . . .	»	9
Brakes . . . . .	»	10
Clutch . . . . .	»	13
Headlamp adjustment . . . . .	»	13
Luggage box and tools . . . . .	»	14
Starting - running - stopping . . . . .	»	14
<b>WIRING DIAGRAM</b>		
For regular machines . . . . .	»	16
For machines equipped with stop lights . . . . .	»	17
For machines equipped with parking lights . . . . .	»	19
Lubrication diagram . . . . .	»	20-21
<b>Periodic maintenance</b>		
Every 4 weeks . . . . .	»	22
Every 1,250 miles (2000 km) . . . . .	»	22
Every 2,500 miles (4000 km) . . . . .	»	24
Every 3,750 miles (6000 km) . . . . .	»	25
Cleaning of scooter . . . . .	»	25
When the scooter remains out of use for sometime . . . . .	»	25
<b>TROUBLE CHART - a Guide to assist in the tracing and rectifying of common faults . . . . .</b>	»	26
<b>MAIN FEATURES . . . . .</b>	»	29
<b>LAMBRETTA AGENTS . . . . .</b>	»	33

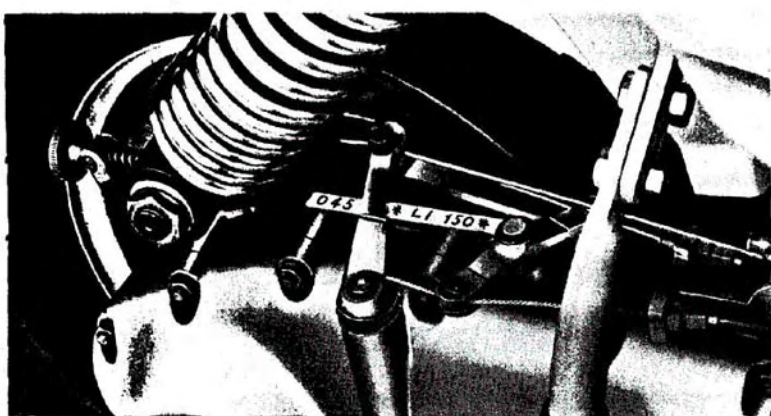
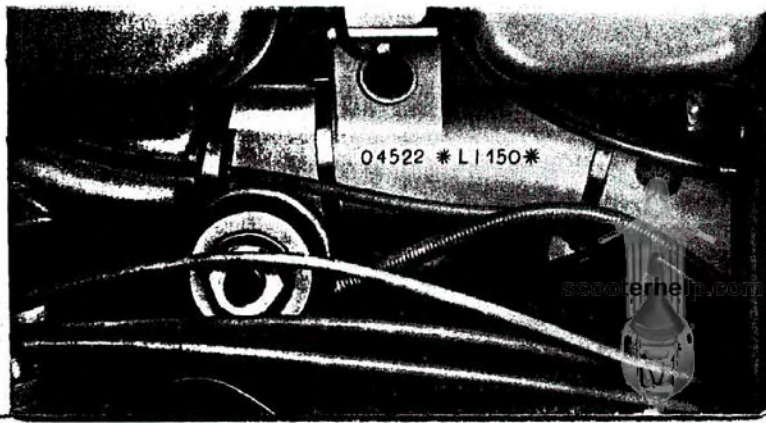

Fig. 1

## IDENTIFICATION OF SCOOTER

The engine and frame numbers, which serve to identify your scooter in accordance with the Rules and Regulations, are stamped as shown in figures 1 and 2. These numbers are repeated on the guarantee card and log book, and should always be quoted when requesting spare parts.

Fig. 2



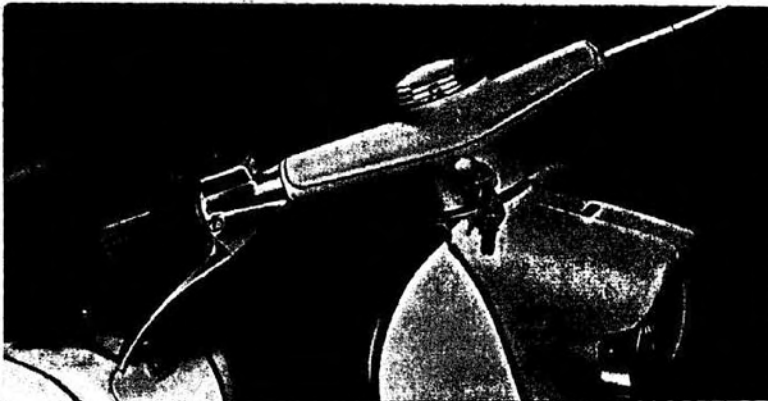

Fig. 3

## KEYS

The set of Keys supplied with your scooter are for the steering lock fitted in the centre front of the handlebar, see Fig. 3, and for the Luggage box situated in the central front rib of the frame, See Fig. 4.

Each key has a number stamped on it and the same number is stamped on the lock, so that in case of loss, a replacement can be obtained by quoting the appropriate number.

Fig. 4

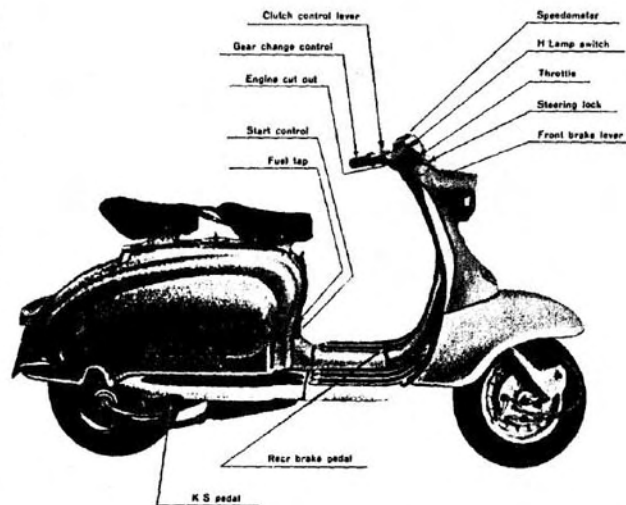
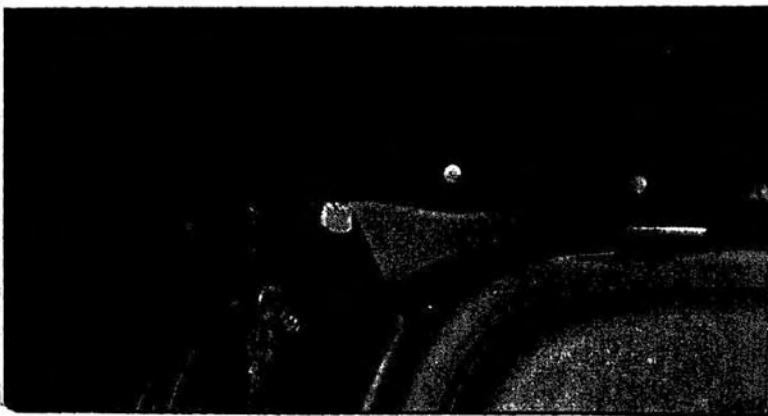

Fig. 5

## CONTROLS

Fig. 3 shows the controls on your scooter. They are:

### On the handlebar

**Right hand:** throttle twist grip and front brake lever, 3-way light switch, with headlamp beam control and horn button. The three positions of the switch are: - « 0 » - Lights off. « 1 » - prior, rear,



speedo, light for night riding in town or country. « 2 » Headlamp speedo, rear light for night riding in country areas.

**Left Hand:** clutch control lever and gear change control.

**Centre:** In front, Steering lock. To lock machine, turn front wheel full lock, left or right and turn key ½ turn. The key can be extracted from lock whether in lock or unlocked position.

On top of handlebar: Speedometer.

Facing driver: Engine cut-out button.

**On the footboard:**

**Right hand side:** Rear brake pedal.

**On the central frame rib** under the front part of saddle.

**On left hand side:** 3-way fuel tap (closed, open, reserve) see fig. 6.

When machine is at stand-still, it is advisable to turn tap to closed position. The fuel tank contains a total of 1.9 galls. (8.7 Lt) of fuel. When riding, tap should be in open position, and when you switch over to reserve you still have 1¾ pints (0.75 Lt) available (in other words a further 15½ miles approximately).

**On Right hand side:** start control. Turn start control lever 180° clockwise (this only when starting on a cold engine). Return to original position as soon as engine is running steadily.

**On Right hand side of machine**

Kickstart pedal. Before kick starting, ensure that gear is in neutral.

Fig. 6

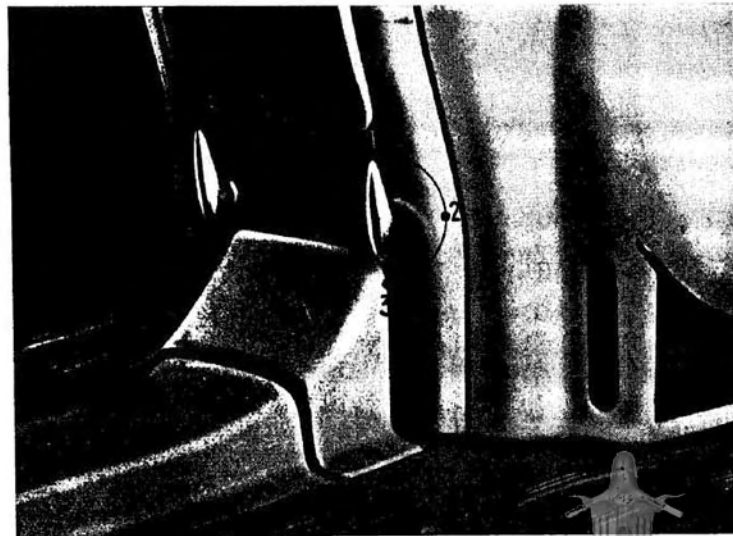

1. Closed

2. Open

3. Reserve

scooterhelp.com

## SERVICE INSTRUCTIONS

### During running-in period

(first 900 miles) keep strictly to the following rules:

- use a mixture of 4 % oil (BP Energol Two Stroke SAE 30) and good standard petrol.
- do not exceed the following speeds:

	1st. gear.	2nd. gear.	3rd. gear.	4th. gear.
miles per hour	12	30	40	55

- do not maintain these speeds for long periods;
- do not climb hills on full throttle;
- do not accelerate at full throttle;
- take great care not to overheat your engine;
- take great care to have your machine fully serviced, as per the service schedule, at the correct time, by one of the authorised service agents.

Remember that the life of your scooter depends entirely on the running-in schedule being properly maintained.

### Fuel - Fuel tank

After the running-in period, continue to use a 4 % petrol mixture.

To reach the fuel tank filler cap: open the lid situated on the central frame rib behind the driver's seat. See Fig. 7.

The tank contains a total of 1.9 gallons (8.5 lt) of which 1 ¼ pints (0,75 Lt) are reserve. (for the fuel tap, see Page 6).



Fig. 7

### Wheels

Tyres 10" x 3.5".

Pressures: front 13 lbs per sq. inch (0.9 kg/sq. cm); rear 18 lbs per sq. inch (1.25 kg/sq. cm) with rider only; rear 32 lbs per sq. inch (2.25 kg/sq. cm) with pillion rider.

Wheels are interchangeable.

To dismantle, lift machine on its stand. The necessary tools will be found in the luggage box (see page 15).

#### To dismantle the front wheel:

- unscrew the four dome nuts fixing rim to hub (care must be taken not to unscrew the other nuts);
- unscrew the two nuts holding tub to trailing links;
- slip wheel from links and hub, taking care not to pinch or bend the front brake and speedometer drive cables.



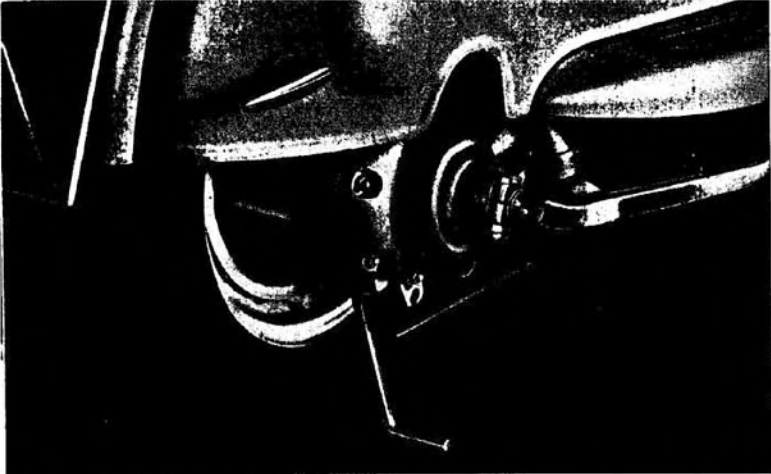

Fig. 8

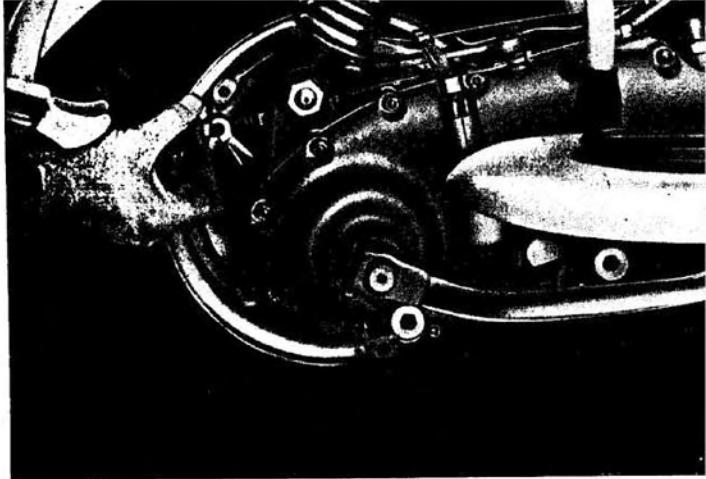

Fig. 9

#### To dismantle the rear wheel:

- fit the wheel lift stand, supplied in Kit, to the lug on crankcase (see fig. 8);
- unscrew the four dome nuts and slip wheel from hub.

#### To dismantle tyre from rims:

- dismantle wheel (as above);
- ensure that tyre is deflated;
- unscrew the four nuts holding the rims.

#### Brakes

Ensure that the brakes are kept regularly adjusted so that the wheel is completely free to rotate, but the braking effect begins immediately the lever or pedal is used. Adjustment is carried out by means of two adjusters (see fig. 9 and 10).

Fig. 10

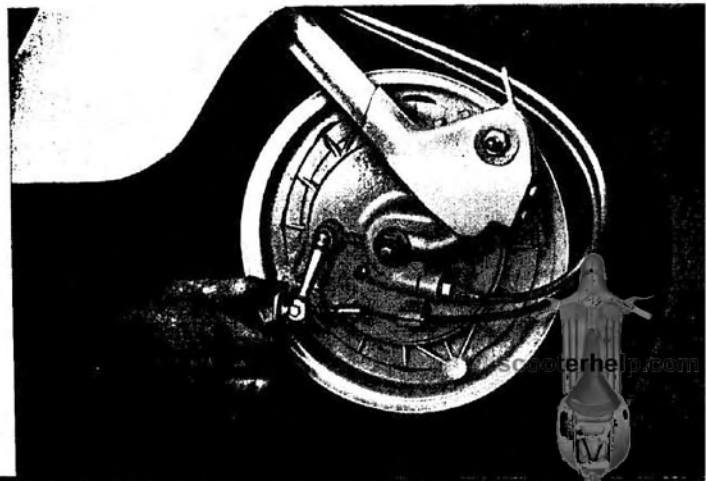

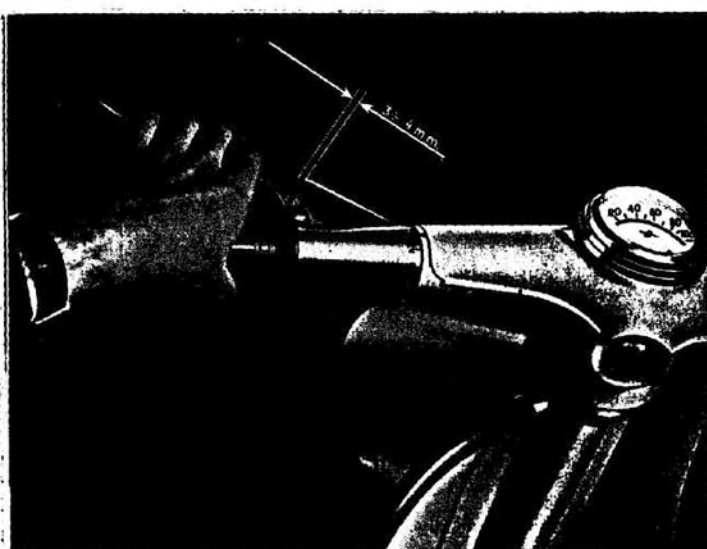

Fig. 11

Fig. 12

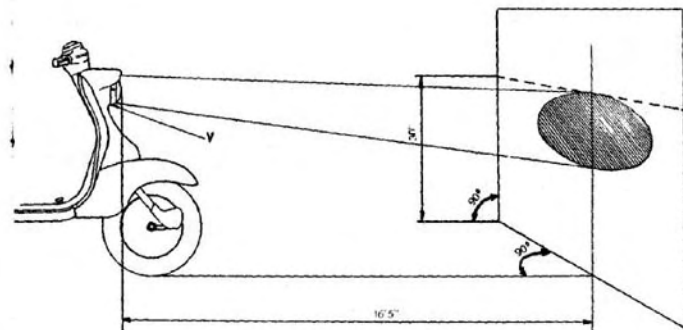
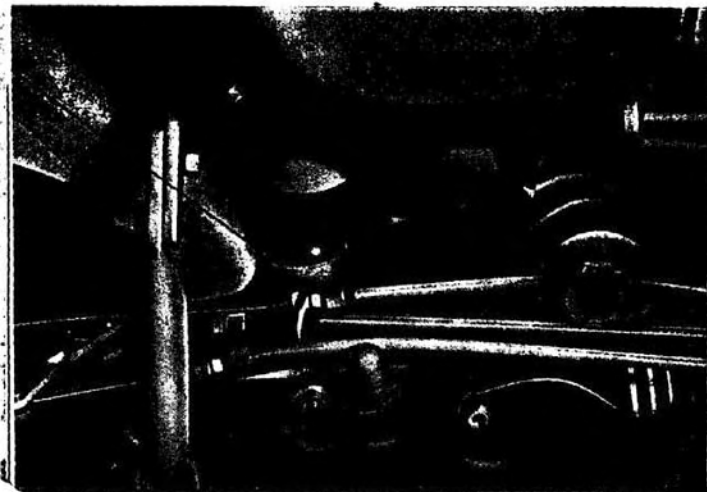

Fig. 13

## Clutch

Keep the clutch constantly adjusted, so that it begins to slip when the clutch lever is in the position shown on fig. 11. The adjustment is carried out by turning the adjuster illustrated in fig. 12.

## Headlamp adjustment

Check tyre pressure (see page 28).

Place a vertical screen as shown in fig. 13.

Put the scooter under the normal load conditions.

Losen the two V screws shown on the headlamp, fig. 13, rotating it on the remaining two screws until the upper edge of the zone illuminated by the dipped beam coincides with the horizontal line traced on the screen.



## Luggage box and tools

The luggage box is moulded into the central frame rib under the front part of the driver's seat. A pair of keys for this box are supplied with the scooter (see page 4). In the luggage box, a tool kit is supplied consisting of:

- 1 double ended box spanner 21 x 14 mm for the spark plug and wheel nuts;
- 1 exagon spanner (10 mm) to be used for unscrewing the plugs of the crankcase;
- 1 spanner 14 x 27 mm for rear wheel nut;
- 1 double ended spanner 8 x 10 mm;
- 1 screwdriver;
- 1 rear wheel lifting stand;
- 1 points file;
- 1 4 mm allen key spanner for trunnion grub screws.

## Starting - Running - Stopping

### To start the scooter:

- place on centre stand;
- ensure that gear is in neutral;
- open fuel tap (see page 7);
- turn starting control lever - only when engine is cold (see page 7);
- keeping throttle to minimum, kick start machine;
- as soon as engine is turning over, give slight acceleration to warm up;
- if the starting control lever has been used, return to original position;
- during cold weather, run engine a few minutes to warm up before using machine.

### To move off:

- bring machine off its stand;
- with engine ticking over, pull clutch lever and put into 1st gear by rotating left twist grip;
- let clutch lever out slowly, accelerating engine gradually to maintain constant revolutions;
- continue to accelerate until you have reached the correct speed to change up to a higher gear.

### To change gear:

- close throttle;
- pull clutch lever;
- insert next gear;
- let clutch lever out slowly, accelerating gradually at the same time.
- Do not hesitate to drop the lower gear, although it will reduce speed.

### To stop engine:

- close throttle;
- pull clutch lever;
- put gear into neutral;
- cut out engine by pressing engine cut out button.

## Wiring Diagram

On the pages 16, 17 and 19 are shown the regular wiring diagram as well as the special ones for the machines equipped with stop or parking lights. Refer to the particular diagram regarding the machine you are owner.

# WIRING DIAGRAM (regular)

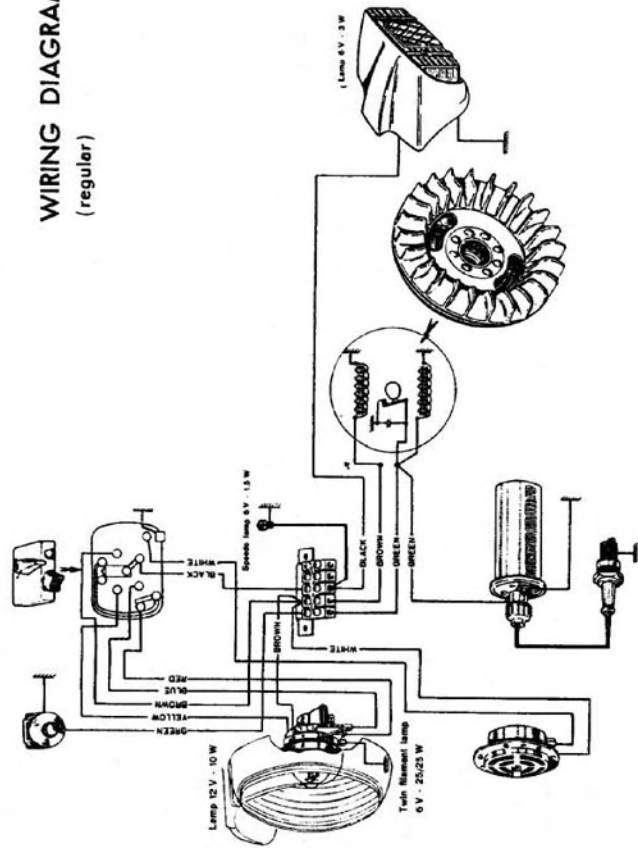

# WIRING DIAGRAM (with stop lights)

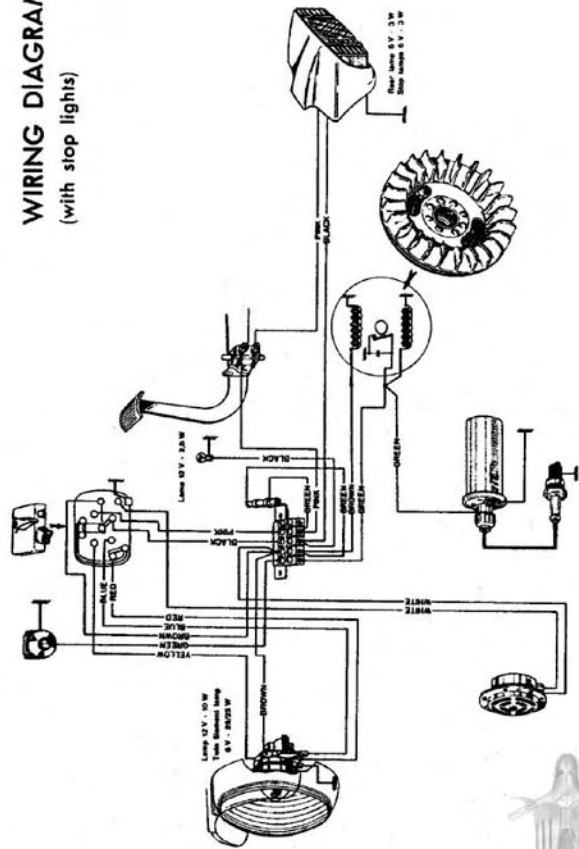

## Machines equipped with parking lights

The machines equipped with parking lights (i.e. with battery) are supplied with a special group assembling rectifier-regulator and a safety fuse for the electrical installation. To reach the 8 Amp. fuse take out the left hand panel of the machine and remove the cover of the little box containing the regulator-rectifier-fuse assembly (see fig. 14-15).

Should all lights not work when placing switch lever to position 1, check if fuse has burnt, replace and look for the cause of the short circuit.

Fig. 14

Fig. 15

## WIRING DIAGRAM (with parking lights)

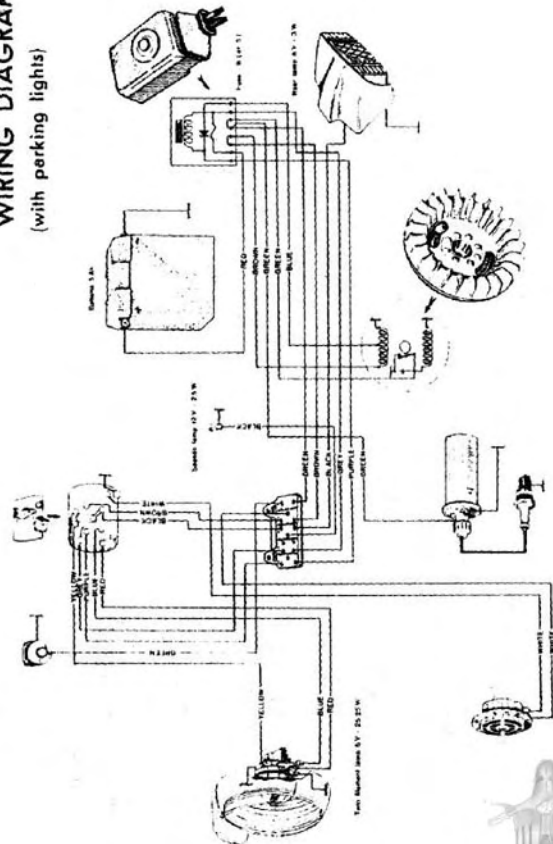

## LUBRICATION DIAGRAM

Every 2500 miles

Every 1250 miles

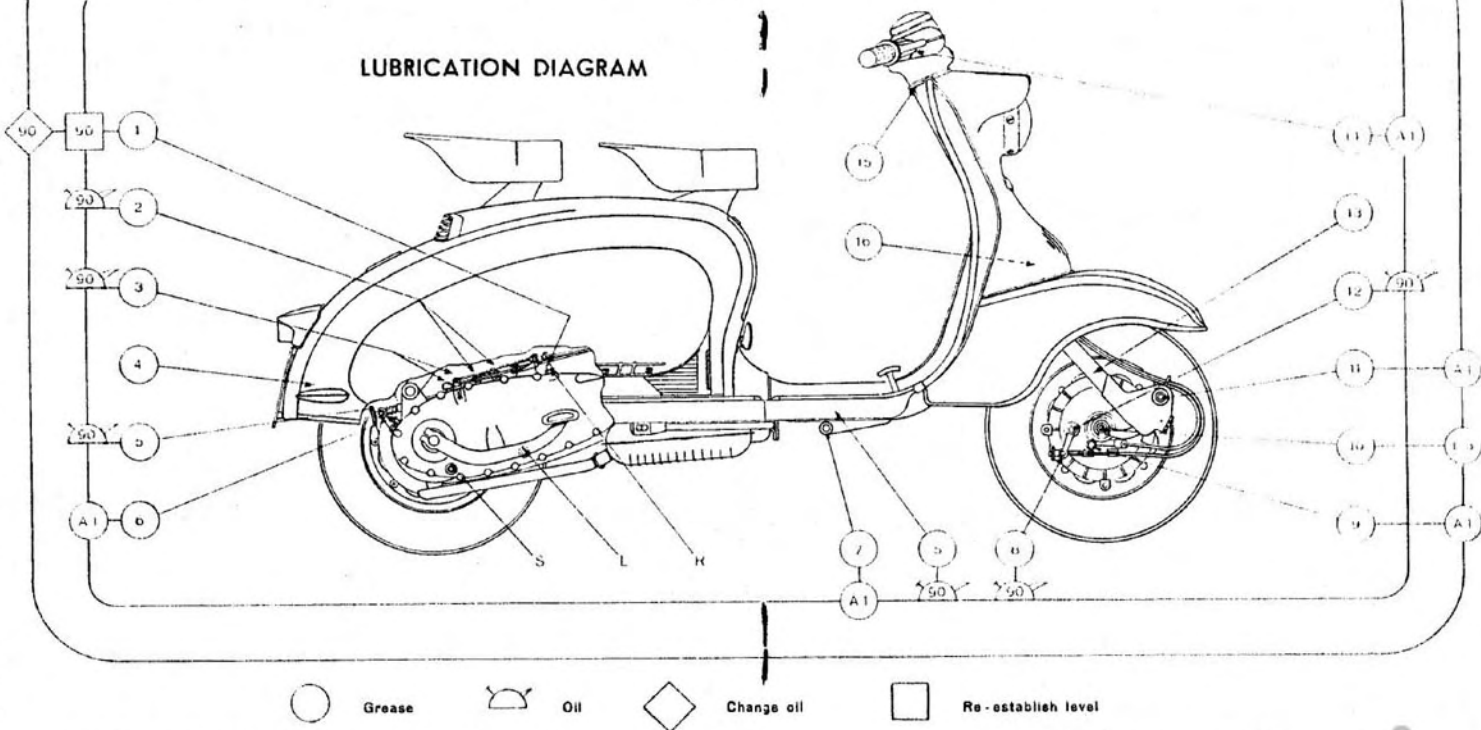

**PERIODIC LUBRICATION** - (1) Crankcase; change oil after first 1000 miles using BP Energol Transmission SAE 90 Oil. (2) Gear change knuckles, twin lever. (3) Clutch and gear cable knuckles. (5) Rear brake knuckles. (6) Rear brake cam pin. (7) Rear brake pedal pin. (8) Front brake knuckles. (9) Speedometer drive box. (10) Front wheel bearings. (11) Suspension link boxes. (12) Front brake cam pin. (14) Handlebar control lever knuckles (front brake, throttle, clutch, gear).

### LUBRICATE THESE PARTS WHEN ASSEMBLING SCOOTER AFTER OVERHAUL —

- Part (2), (3), (5), (8), (12), should be lubricated with grease BP Energrease A1.
- Steering ball bearings, parts (15) and (16) should be lubricated with grease BP Energrease L.
- Side panel hooks (4) and handlebar control lever knuckles (14) should be lubricated with grease BP Energrease A1.
- Front suspension helical spring (13) should be smeared with grease BP Energrease A1.
- Introduce some drops oil SAE 30 in control cable coating before mounting wires.

R = oil filler plug.

L = oil level plug.

S = oil drain plug.

90 means BP Energol Transmission SAE 90 oil.

A1 means Energrease A1.

L3 means Energrease L3.



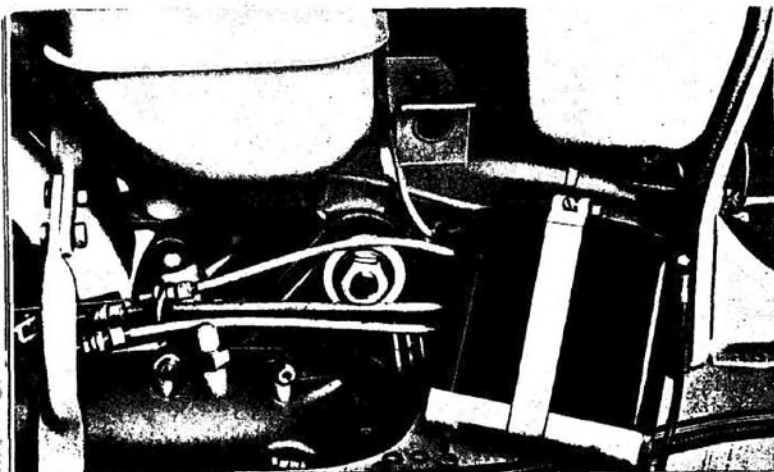

Fig. 16

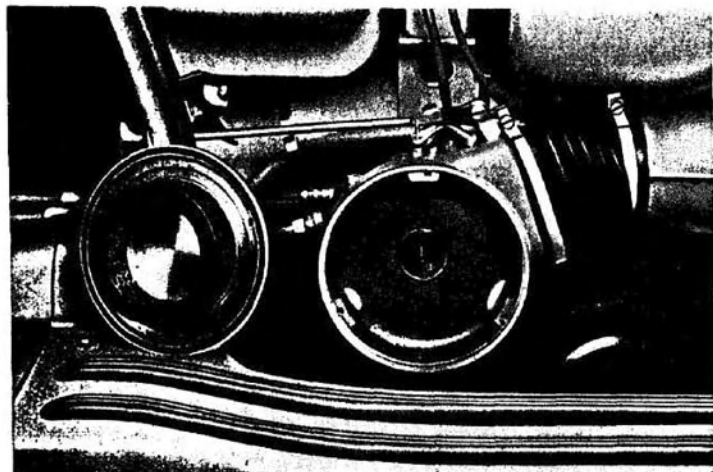

Fig. 17

## PERIODIC MAINTENANCE

### Every 4 weeks:

Add distilled water to parking light battery until water is about  $\frac{1}{4}$ " (mm. 5) over the top of cells. To do this it is necessary to take battery out from its seat, as shown in fig. 16.

Grease battery terminals with vaseline.

### Every 1250 miles (2000 km):

Brakes: check adjustment (see page 11).

Spark plug: check, clean electrodes with kit file and adjust gap to 0.020"-0.025" (mm. 0.5-0.6).

Carburetor air filter: disassemble (see fig. 17) and clean by soaking in petrol.

1 - oil filler plug 2 - oil level plug 3 - oil drain plug

Fig. 18

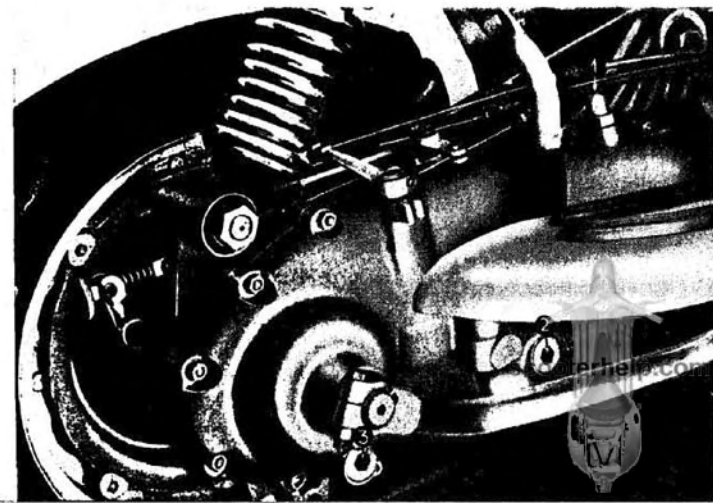

### Lubrication:

#### Crankcase:

re-establish level with oil **BP Energol Transmission SAE 90**.

To do this, unscrew oil level and filler plugs, pour in oil until this begins to flow from level plug (see fig. 18).

Clutch cable knuckles

Gear change cable knuckles, twin lever.

Rear brake knuckles.

Front brake knuckles.

Front brake cam pin.

Rear brake cam pin.

Handlebar control lever knuckles.

Rear brake pedal pin.

Lubricate with  
**BP Energol  
Transmission SAE 90**

Grease with  
**BP Energol A1**

#### Every 2500 miles (4000 km):

Clutch control: check adjustment (see page 12)

Flywheel magneto contact breaker points: clean and set gap 1/64" (mm 0.35-0.45): we suggest that adjustment on this part should be carried out by authorised Service Agent.

Flywheel magneto cam oil pad: lubricate.

### Lubrication:

#### Crankcase:

drain oil completely through drain plug (see fig. 18) when the engine is warm.

Replace drain plug, unscrew filler and level plugs; pour in oil until this flows from level plug. Quantity of oil needed 1 1/4 pints of **BP Energol Transmission SAE 90**.

#### Speedometer Drive Box:

grease with gun through nipple. **BP Energol A1**.

#### Front wheel Bearings:

grease with gun through nipples. **BP Energol L3**.

#### Suspension Link Boxes:

grease with gun through nipples. **BP Energol A1**.

#### Every 3750 miles (6000 km):

Decarbonise cylinder, cylinder head, piston head and silencer. We strongly recommend that this work be carried out by the Authorised Service Agent.

#### Cleaning of scooter

- Wash engine with petroleum, using a brush. Dry with clean rags.
- Wash cellulosed and plastic parts with water, using a sponge. Dry with chamoise leather. **Do not use petrol or petroleum**, otherwise damage will result.

#### When the scooter remains out of use some time:

- wash and dry carefully as above;
- drain all petrol from tank and carburettor;
- clean tank and carburettor filters;
- unscrew spark plug, insert few drops of engine oil, rotate engine by hand two or three times to ensure a protective oil film in cylinder barrel. Replace spark plug;
- coat with anti-rust grease all non-painted parts;
- take out battery, place in dry place to avoid freezing; have it re-charged monthly at an Authorised Service Agent;
- lift machine off the ground by placing blocks carefully under frame, tyres should not reach the floor;
- clean and deflate tyres;
- cover machine.



## TROUBLE CHART

### A GUIDE TO ASSIST IN THE TRACING AND RECTIFYING COMMON FAULTS

#### Engine fails to start, or stops immediately

Possible cause:	Remedy:
Irregular flow of fuel to the carburator	clean fuel lines and filters. clean out jet.
Flooded carburettor	close fuel tap, open throttle and endeavour to kick start. Or, unscrew and dry out spark plug, replace plug and kick start the motor
Damaged carburettor float	have it replaced at Service Agent.
(if current is reaching H.T. Lead) — dirty spark plug	unscrew and clean.

— electrodes non adjusted	adjust to 0.020" - 0.025" (0.5-0.6 mm).
— faulty spark plug (if current does not reach H. T. Lead)	replace with a new one.
— contact breaker points faulty	take machine to Authorised Service Agent.
— Flywheel magneto or H. T. coil circuits shorting	take machine to Authorised Service Agent.

#### Engine knocking

Incorrect mixture	drawn out and replace with correct fuel mixture.
Pre-ignition	clean spark plug. Decarbonise cylinder head.
Ignition too far advanced	see Authorised Service Agent.

#### Engine misfires

Irregular flow of fuel to the carburettor	check and clean out fuel line.
---	--------------------------------



Spark plug electrode gap too wide	re-adjust to correct gap.
Dirty spark plug	unscrew and clean out.
Contact points dirty or not adjusted	clean and adjust gap between points.

### Explosion in carburettor

Pre-ignition due to excessive overheating of spark plug	change spark plug for one with a higher heat range.
Carbon deposits on spark plug	clean out spark plug.

### Loss of power or excessive overheating

Weak Mixture	adjust by closing slightly the carburettor air screw.
Incorrect timing	adjust timing. Take machine to an authorised service Station.
Exhaust port or silencer partially obstructed	clean out port or silencer.
Cylinder Head loose	tighten cylinder head nuts.

### MAIN FEATURES

Overall length . . . . .	71 3/4" (m. 1.825)
Overall width . . . . .	28" (m. 0.710)
Overall height . . . . .	40 3/4" (m. 1.038)
Ground clearance . . . . .	6 1/2" (m. 0.165)
Wheel base . . . . .	51" (m. 1.290)

Central frame in steel tube.

Bodywork in pressed steel sheet.

Front suspension by means of trailing links, variable pitch helical springs.

Rear-suspension, swinging engine unit with shock absorber carrying a helical spring of unequal pitch.

Centre stand with two arms.

Unladen weight . . . . .	231 lbs. (105 kg.)
Fuel tank capacity . . . . .	1.9 imp. gals (2.3 U.S. gals 8,7 Lt.)

#### Maximum speed

driver bent onward (according to the CUNA standard) . . . . .	52.54 mph. (84.86 km/h).
driver sitting . . . . .	48.5.50 mph. (78.80 km/h).

#### Fuel consumption (according to CUNA standard)

. . . . .	120 m. p. imp. gal (74 m. p. U. S. gal 2,2 Lt./100 km.).
-----------	--

Uphill . . . . .	4th. gear 9%.
	3rd. gear 14%
	2nd. gear 22%.
	1st. gear 35%





## Engine

two stroke single cylinder. Forced air cooled.

Bore	57 mm
Stroke	58 mm
Capacity	148 cc.
Compression ratio	7.0
Maximum output	6.5 HP. at 5300 r.p.m.
Lubrication	Petrol
Starting	Kickstart pedal

## Carburettor

Dell'Orto MB 19-BS 5. Silencing air filter - calm air - intake.

## Ignition

by flywheel magneto and external H. T. coil - Spark Plug. 225 Heat Range. Bosch scale, long react. Fixed advanced ignition.

## Clutch

multi-disc in oil bath.

## Transmission

double row chain

Four speed constant mesh in oil bath.

Gear ratio:

1st.	1:	13.95
2nd.	1:	9.00
3rd.	1:	6.67
4th.	1:	5.22

## Wheels and brakes

Interchangeable wheels.

Rims: in pressed sheet, split in two halves.

Brakes: internal expansion.

Tyres: 3.5' x 10".

Tyre Pressures:

Front: 13 lbs./sq.in. (0.9 kg/cm<sup>2</sup>)

Rear (rider only): 18 lbs./sq.in. (1.25 kg/cm<sup>2</sup>)

Rear (with pillion): 32 lbs./sq.in. (2.25 kg/cm<sup>2</sup>)

## Electrical equipment (machines without parking and stop lights)

Generator: flywheel magneto 27 W 4 pole.

Lights: 1 twin filament headlamp bulb 6V, 25/25W;

1 pilot light bulb in headlamp 12 V, 10 W;

1 rear lamp bulb 6V, 3W;

1 speedometer bulb 6 V, 1,5 W.

## Electrical equipment (machines equipped with stop lights)

Generator: flywheel magneto 27 W 4 pole.

Lights: 1 twin filament headlamp bulb 6V, 25/25W;

1 pilot light bulb in headlamp 6V, 5W;

1 rear lamp bulb 6V, 3W;

2 stop light bulbs 6V, 3W;

1 speedometer bulb 12V, 2.5W.



## Electrical equipment (machines equipped with parking lights)

Generator: flywheel magneto 27 W 4 pole.

Fuse: 8 (or 5) Amp.

Battery: 5 Ah.

Lights: 1 twin filament headlamp bulb 6V, 25/25W;  
1 parking or pilot light bulb in headlamp 6V, 3W;  
1 rear lamp bulb 6V, 3W;  
1 speedometer bulb 12V, 2.5W.

### Note

In Great Britain use grease according to the following equivalence

BP Energrease A<sub>1</sub> = BP Energrease L<sub>2</sub>

BP Energrease L<sub>3</sub> = BP Energrease L<sub>2</sub>

# Lambretta

# AGENTS

## FOREIGN IMPORTERS

**ADEN** - PAUL RIES & SONS Ltd.  
ADEN.

**ALASKA** - HEINZ BORCHARD  
FAIRBANKS.

**ALGERIE**  
(Oran) - C.O.D.I.V.A.  
12, rue de Nancy - ORAN.  
(Algier) - OTEINA  
86, Rue Sadi Carnot - ALGIERS.  
(Bône) - J.A.K.S.  
BONE - 6, rue Prosper Dubourg.

**ANGOLA** - GUEDES & ALMEIDA Ltda.  
LUANDA.

**ARGENTINE REPUBLIC**  
SIAM DI TELLA Ltda.  
Florida 602 - BUENOS AIRES.

**ARUBA**  
VIANA AUTO SUPPLY CO. INC.  
Bernardstraat n. 101  
P. O. B. 362 - SAN NICOLAS  
ARUBA.

**AUSTRIA** - RUDOLF SMOLINER  
Stubenring, 4 - WIEN.

**AUSTRALIA**  
LAMBRETTA DISTRIBUTORS Ltd.  
350, George Street - SYDNEY.

**AUSTRALIAN NEW GUINEA**  
W. R. CARPENTER & CO. Ltd.  
16 O'Connell Street - SYDNEY N.W.S.

**BAHAMAS** - BAHAMA ENGINES Ltd.  
P. O. Box 1658 - NASSAU.

**GELGIAN CONGO**  
GARAGE DU POOL S.c.r.l.  
Avenue Van Gèle, 6 - LEOPOLDVILLE.

**BELGIUM-LUXEMBURG** - NETCO S. A.  
200, Avenue Louise - BRUXELLES.

**BERMUDA** - THE BERMUDA MOTOR &  
CYCLE ACC. Ltd.  
The Lucas House - HAMILTON.

**BOLIVIA** - MONTELLANO Y CIA, Ltd.  
Casilla 1015 - LA PAZ.

**BRAZIL** - LAMBRETTA DO BRASIL S. A.  
Praça de Republica 468 - SAO PAULO.

**BRITISH EAST AFRICA** (Kenya, Uganda,  
Tanganyika, Zanzibar) - F. BOERO & C.  
Coronation Avenue - P. O. B. 30499  
NAIROBI.

**BRITISH GUYANA** - THE AUTO SUPPLIES  
Co.  
30 Hadfield & Lombard Street  
GEORGETOWN, Demerara.

**BRITISH SOMALILAND**  
PAUL RIES & SONS  
BERBERA-HAGEISHA.

**BRITISH WEST INDIES**  
(Antigua) - F. T. FARFAN & SON Ltd.  
Corn Alley - ST. JOHN'S  
(Cayman Islands)  
CAYMAN ISLANDS ENTERPRISES Ltd.  
GEORGE TOWN, Grand Cayman  
(Trinidad) - F. T. FARFAN & SON  
30 St. Vincent ST.  
PORT OF SPAIN

(Jamaica) - GERRY ATTECK  
43½ Halfway Tree Road  
KINGSTON, Jamaica

**CAMBODGE** - CHAKRAVILI S.A.R.L.  
115, Phlou Preah Manivong  
B. P. 65 - PHNOM-PENH.

**CAMEROUN** - KING MOTORS Ltd.  
DOUALA.

**CANADA**  
(Alberta) - ALBERTA CYCLE & MOTOR  
Co.  
10313 - 96th St. - EDMONTON.  
(British Columbia) - FRED DEELEY Ltd.  
606 East Broadway  
VANCOUVER B. C.

(Manitoba) - NORTHWEST CYCLE &  
MOTOR CO.  
551 Logan Avenue - WINNIPEG.

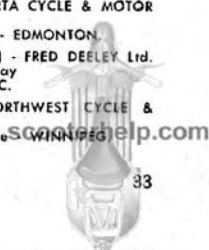

(Ontario) - PERCY A. McBRIDE Ltd.  
69 Queen Street - TORONTO.  
(Quebec) - BENTLEY'S CYCLES AND  
SPORT Ltd.  
2087 Bluary Street - MONTREAL.

CEYLON - COLONIAL MOTORS Ltd.  
297, Union Place - COLOMBO.

CHILE - E.M.M.S.A.  
Calle Ahumada 254 - Of. 410  
SANTIAGO.

COLUMBIA  
AUTOTECNICA COLUMBIANA Ltda.  
Carrera 50 n. 37-15  
Apartado Aereo 1065 - MEDELLIN.

CONGO (A.E.F.) - SOCIETE COMMER-  
CIALE DU KOUILOU NIARI  
BRAZZAVILLE.

COSTA RICA  
CASTRO ZELEDON CIA Ltda.  
P. O. Box 774 - S. JOSE.

CUBA - IMPORTADORA TODORUEDA S.A.  
Marina 107 - LA HABANA.

CYPRUS - G. TH. PIERIDES & SONS Ltd.  
42-44 Phanerameni Street - NICOSIA

DAHOMY (A.O.F.) - WALKDEN & CO.  
COTONOU.

DENMARK - NORDISK DIESEL A/S.  
Borgmester Christiansensgade, 55  
KOPENHAGEN.

DOMINICAN REPUBLIC  
GUILLERMO A. RISK  
P. O. Box 213 - CIUDAD TRUJILLO.

DUACH NEW GUINEA - NIEUW GUINEA  
IMPORT EXPORT MAATSCHAPPY N.V.  
HOLLANDA.

EGYPT  
PAUL ZERVUDACHI & CO.  
12 Rue Sidi-El-Khiashi (Kam El Dick)  
ALEXANDRIE.

EL SALVADOR - ROBERTO DAGLIO  
Plaza 14 de Julio - SAN SALVADOR.

EQUADOR - DANIEL CADENA A. & HIJOS  
Apartado 229 - QUITO.

ERITREA - PAUL RIES & SONS Ltd.  
Av. Haile Selassie 1st 8-12 - ASMARA.

ETHIOPIA - PAUL RIES & SONS Ltd.  
123 Wavell Street - ADDIS ABEBA.

FIJI ISLANDS - BHANABHAI & CO.  
P.O.B. 274 - SUVA.

FINLAND - AUTOLA OY  
Mannerheimintie 5 - HELSINKI.

FORMOSA (TAIWAN) - INTERNATIONAL  
TRADE & DEVELOPMENT  
55, Po Ai Road - TAIPEI.

FRANCE - LAMBRETTA SOC. ANONYME  
FRANCAISE  
53 rue de Faisanderie - PARIS, XVI.

FRENCH GUINEA - SOCIETE COMMER-  
CIALE DE L'OUEST AFRICAIN  
CONAKRY.

FRENCH GUYANA - F. TANON & CIE.  
CAYENNE - 9, Chaussée Sartines.

FRENCH SOMALILAND  
ANCIENS COMPTOIRS RIES  
P. O. Box 106 - DJIBOUTI.

GABON (A.E.F.)  
HATTON & COOKSON  
LIBREVILLE.

GERMANY - West Zone  
WILHELM SCHLOTE  
Kueterwall 24 - HAMBURG 11

GHANA  
A. G. LEVENTIS & CO. Ltd.  
P. O. B. 642 - ACCRA.

GIBRALTAR - ROCK MOTORS Ltd.  
Devil's Tongue - WATERPORT.

GOA (Portuguese Indies)  
NACHINOLCAR LTDA - Apartado 4513  
Praça do Comercio - GOA.

GREAT BRITAIN  
LAMBRETTA CONCESSIONARIES Ltd.  
Beverly Works - Kingston-by-Sea  
LONDON, S. W. 20.

GREECE - ETALLAS S. A.  
73, Avenue Syngrou - ATHENS.

GUADELOUPE  
COMPTOIR BOREL & GERARD  
B. P. 62 - POINTE A' PITRE.

GUATEMALA  
FEDERICO BOEF & CO. Ltd.  
GUATEMALA - 12 Calle 3-20, Zona 1.

HAITI - LUCIANI BEHRMANN  
Rue du Mag. de l'Etat  
PORT AU PRINCE.

HAWAII  
GEORGE MOTOR CO. Ltd.  
1461, Kapiolani Blvd.  
HONOLULU T. H.

HOLLAND - LEONARD LANG  
Stadhouderskade, 114 E  
AMSTERDAM 2.

HONG KONG - GILMAN CO. Ltd.  
HONG KONG - P.O. B 56

ICELAND - ORKA Ltd.  
Laugaveg 166 - REYKJAVIK.

INDIA - AUTOMOBILE PRODUCTS OF  
INDIA Ltd.  
Agra Road - BHANDUP - BOMBAY.

INDONESIA - ERIKA CONCERN N. V.  
1, Merdeka Barat - DJAKARTA.

IRAN - SOCIETE ANONYME NOUR  
Avenue Lalezar - TEHRAN.

IRAQ - W. J. COKER & CO. Ltd.  
Al-Rashid Street - BAGHDAD.

IRELAND - HUET BROTHERS Ltd.  
7/8 Bachelors Walk  
DUBLIN.

ISRAEL - VE-SRA Co. Ltd.  
25 Derech Petach Tikvah - TEL AVIV.

ITALIAN SOMALILAND  
FRANCESCO BOERO  
P. O. Box 23 - MOGADISCIO.

IVORY COAST - C.E.C.A.C.I.  
ABIDJAN - 3, Avenue Houdaille.

JAPAN - KOTOBUKIYA SHOTEN  
75-3 chome Kyobashi-Higashi-ku  
OSAKA.

KENYA - See: British East Africa.

LA REUNION - SOCIETE SAMAT  
Pointe des Galets  
ST. DENIS.

LAOS - SOUVANNASENG S.A.R.L.  
Ban Phia Wat - B. P. 171  
VIENTIANE.

LIBAN - IBRAHIM R. AUDI  
B. P. 316 - 11, rue Patriarche Hayek  
BEYROUTH.

LYBIA - LIBIA MOTOR S.p.A.  
Sciarra Istiklol 358 - TRIPOLI.

MADAGASCAR - LANDIS MADAGASCAR  
B.P. 633 - TANANARIVE.

MALTA - MIZZY BROTHERS Ltd.  
283, Kingway - VALLETTA.

MARTINIQUE  
EDOUARD BOULLANGER FILS  
B. P. 315 - FORT DE FRANCE.

MAURITIUS - ADAM & CO. Ltd.  
1, Queen Street - PORT LOUIS.

MEXICO - LAURENCE P. SOURS  
Av. Morelos 89 - MEXICO D. F.

MOROKKO - FORGES DE BAZAS  
Rue de Bazas 31 - CASABLANCA.

MOZAMBIQUE - SOCIEDADE COMERCIAL  
ITALO MOÇAMBICANA  
Caixa Postal 1209  
LOURENÇO MARQUES.

NEW CALEDONIA  
SOCIETE DE ROUVRAY  
1, Av. J. Jaurès - NOUMEA.

NEW ZEALAND - P. COUTTS & CO. Ltd.  
Grey Lynn - 116 Great North Road  
AUCKLAND W. 2.

NICARAGUA  
MANTICA FRANCISCO & CIA Ltd.  
MANAGUA - Apartado Postal 789.

NIGER (A.O.F.)  
COMPAGNIE DU NIGER FRANÇAIS  
NIAMEY.

NIGERIA - LEVENTIS MOTORS Ltd.  
LAGOS.

NORTH BORNEO  
BORNEO MOTORS Ltd.  
70, Orchard Road - SINGAPORE.

NORTH MOROKKO - See: Marokko.

NORWAY - LAMBRETTA A/S  
Bygdo Alle 60 - OSLO.

OKINAWA - SANKI PRODUCTS Co.  
P. O. B. Miebashi 84, 19 - Kumi, 5 - Ku  
NAHA OKINAWA, JAPAN.

OUBANGUI CHARI (A.E.F.) - SOCIETE  
COMMERCIALE DU KOUILOU NIARI  
BANGUI.

PAKISTAN - J. TYLER & CO.  
Mc Lead Road - KARACHI.

**CHIAVARI (Genova)** - BOGGIO DOMENICO - Piazza Stazione, tel. 25-04.  
**CHIETI** - MARINOZZI E PIERMATTEO Corso Marruccino, 124.  
**CIVITAVECCHIA (Roma)** - SORATEC S.r.l. P. Santo Spirito 7, tel. 33-01.  
**COMO** - ORESTE PEVERELLI Via Rubini 18, tel. 20-610.  
**CONEGLIANO (Treviso)** - MODOLO CORRADO - Via Fenzi 6, tel. 52-05.  
**COSENZA** - Rog. RAOUL MIGLIANO Viale Alimena 49, tel. 22-04.  
**CREMONA** - BRUNO BARBIERI Via Trento Trieste 132-134, tel. 28-92.  
**CUNEO** - CHIANALE FRANCESCO Corso Gesso 11-bis, tel. 23-60.  
**DARFO (Brescia)** - ANDREA ZOPPETTI Tel. 34.  
**DOMODOSSOLA (Novara)** - SBARDELLATI LUCIANO Corso F.lli di Dio 19, tel. 22-52.  
**ENNA** - LIBORIO BRUNO & C. Piazza Neglia 3, tel. 109.  
**ERBA (Como)** - CARLO VALSECCHI Via Milano 2, tel. 61-470.  
**ESTE (Padova)** - FERRARESE UMBERTO & C. S.r.l. Piazza Maggiore 27 - tel. 55-04.  
**FAENZA (Ravenna)** - S.I.M.A.A. S.r.l. Via D. Torelli 1/8, tel. 820.  
**FELTRE (Belluno)** - ORESTE BRANDALISE Via Tezze 5, tel. 23-98.  
**FERRARA** - Dr. GULINATI CARLO ALBERTO Via Garibaldi 61, tel. 33-000.  
**FIRENZE** - F.LLI PRESENTI S.A.I. Via Giotto 28, tel. 60201.  
**FIRENZE** - GARAGE ZANIRATTI S.r.l. Via F.lli Rosselli 55, tel. 45-341.  
**FOGGIA** - SALDEST Viale 24 Maggio 34, tel. 11-36.  
**FOLIGNO (Perugia)** - PAOLO NEGRI Via Rutili 2-F, tel. 23-36.  
**FORLÌ** - FRATELLI BAGNOLI Viale Vittorio Veneto 31, tel. 22-084.

**FORMIA (Latina)** - OFF. GARAGE TATTA Via Vitruvio 115, tel. 41.  
**FROSINONE** - FRATELLI CORVI C.so della Repubblica 50, tel. 37-39.  
**GALLARATE (Varese)** - FRANCO NO. SEDA - Via Mercanti B, tel. 20-139.  
**GENOVA** - S.r.l. VINELLI & C. Via Dante 59-r, tel. 51-773.  
**GENOVA SAMP.** - CAROTTI & C. S.a.s. Via Federico Avio 43-r, tel. 41-149.  
**GORIZIA** - ALDO MEROLLI Via Garibaldi 5, tel. 27-23.  
**GROSSETO** - COSTANZO ARZILLA Via Gramsci 2, tel. 28-21.  
**IMOLA (Bologna)** - CREMONINI ENZO Via Emilia 243, tel. 32-62.  
**IMPERIA** - PAOLO BARNATO Via Garosio 2, tel. 84-02.  
**ISERNIA (Campobasso)** - TULLIO TEDESCHI Corso Garibaldi 27, tel. 24-60.  
**IVREA (Torino)** - GUIDO ENRIELLO Via D'Azeglio 38, tel. 41-81.  
**LANCIANO (Chieti)** - LUIGI MERCA-DANTE Via Luigi De Crecchia 10, tel. 32-49.  
**L'AQUILA** - CESARE FIAMMA C.so Vittorio Emanuele 172-174 tel. 31-63.  
**LA SPEZIA** - ROSSI NELLA IN COZZANI Via di Monale 21-23r, tel. 25-386.  
**LATINA** - BODEMA S.r.l. Via E. di Savoia 20, tel. 36-27.  
**LECCE** - C.I.R. di SALVATORE LEGGIERI Via 95 Fanteria 34, tel. 28-05.  
**LECCO (Como)** - SPREAFICO ROMANO C.so C. Alberto 14, tel. 24-750.  
**LIVORNO** - A.I.C.A. S.r.l. P.za D. Chiesa 14, tel. 24-266.  
**LODI (Milano)** - GIORGIO ESPOSTI Via Solferino 27, tel. 30-43.  
**LUCCA** - GIOVANNI MEI di ALBERTO E GIOVANNI Via Filippino 195, tel. 60-83.  
**LUGO (Ravenna)** - MUCCINELLI BRUNO Via Boracca 59, tel. 20-53.

**MACERATA** - Ditta CARLO GRAZIANO Corso Cavour, 102, tel. 37-37.  
**MANTOVA** - ALDO MINGHETTI Via Principe Amedeo 26-a, tel. 59-15.  
**MATERA** - S.V.E.A.R. S.r.l. Via Lucana 126, tel. 11-04.  
**MERANO (Bolzano)** - AUTORIMESSA CENTRALE S.r.l. Via della Corte 31, tel. 26-330.  
**MESSINA** - GIANNETTO & CUCINOTTI Via dei Verdi 20, tel. 10-705.  
**MILANO** - MINETTI S.p.A. Via Filetto 7, tel. 981-987.  
**MILANO** - MILANO SCOOTER S.r.l. Via Paulla 11, tel. 580-670.  
**MODENA** - M.C.M. S.r.l. Via Emilia 251, tel. 24-800.  
**MONDOVI' (Cuneo)** - AIRALDI STEFANO Corso Statuta 14, tel. 23-74.  
**MONZA (Milano)** - GHEFER & C. S.N.C. Via C. Alberto 22, tel. 20-30.  
**NAPOLI** - SCOOTER del Dr. L. CASTINO Via Nazario Sauro 30-32, tel. 392-983.  
**NAPOLI** - ITALMOTOR S.r.l. P.za Capuana 13, tel. 352-157.  
**NOVI LIGURE** - BONELLI LUIGI Via Pavese 3, tel. 20-37.  
**NUORO** - RONDONI GIACOMO Piazza Vittorio Emanuele 5, tel. 23-24.  
**ODERZO (Treviso)** - F.lli SCARDELLATO S.A.S. - Via Garibaldi 6-12, tel. 72-100.  
**ORVIETO** - F.lli STORTI P.za Repubblica 16, tel. 51-38.  
**PADOVA** - GIAMPIETRO TUROLLA Via Foscolo 13-c, tel. 27-104.  
**PALERMO** - CO.RI. S.r.l. Via Paolo Paternostro 3b, tel. 12-388.  
**PAOLA (Cosenza)** - CALOMINO CUSTODIO - Via del Cannone.  
**PARMA** - Ditta CARLO PRADA Via Petrarca 1, tel. 27-227.  
**PAVIA** - G. VENCO & C. Via Gildarelli 14, tel. 23-228.  
**PERUGIA** - TAGLIAMONTE ARTURO Via L. Masi 8, tel. 20-220.

**PESARO** - MOCHI ZAMPEROLI LUCIANO C. XI Settembre 310, tel. 42-45.  
**PESCARA** - RADAR di VITTORIO LUCIANI - Corso Italia 219/221 tel. 211-228.  
**PIACENZA** - BARIOLA BRUNO e FRANCO S.A.S. Via Colombo 44, tel. 30-07.  
**PINEROLO (Torino)** - CAROSSO GIUSEPPE - Via Salvezza 2, tel. 27-08.  
**PIOMBINO (Livorno)** - CRISTIANINI ALDO - Corso Italia 76, tel. 22-68.  
**PISA** - LIVIO DEL SEFFIA & C. Via C. Cattaneo 1, tel. 23-025.  
**PISTOIA** - EMPORIO DELL'AUTO C. Vitt. Emanuele 23, tel. 25-44.  
**PORDENONE (Udine)** - MOTOTECNICA C. Garibaldi 42, tel. 23-22.  
**PORDENONE (Udine)** - BRISOTTO BRUNO - Corso Garibaldi 31, tel. 26-13.  
**PORTO SAN GIORGIO (Ascoli Piceno)** - PETRACCI FERRUCCIO Via Naz. Adriatica, tel. 92-48.  
**POTENZA** - S.V.E.A.R. s.r.l. Via Marconi  
**RAGUSA** - Ditta GIACOMO GATTUSO Via Tenente Lena 18, tel. 24-71.  
**RAVENNA** - EVARISTO DE STEFANI. Via Rasponi 1, tel. 36-03.  
**REGGIO CALABRIA** - S.A.M.O.R. S.r.l. Viale Amendola 29, tel. 11-83.  
**REGGIO EMILIA** - S.C.I.A.M. Via E. San Pietro 55, tel. 22-676.  
**RIETI** - ANGELETTI AGOSTINO Piazza Marconi 2, tel. 32-28.  
**RIMINI** - ADRIATICA SCOOTERS di Ing. F. CAVARA & G. VETTORI P. 3 Martiri 45, tel. 25-39.  
**ROMA** - C.A.M.A.R.A. Via S. Nicolò da Tolentino, 5 Tel. 471-251.  
**ROVERETO (Tranto)** - MANICA EMILIO Via Dante 43-45, tel. 37-78.  
**ROVIGO** - GINO GIUSEPPE MANTOVANI Via Umberto I° 31, tel. 53-29.

PANAMA - CARLOS PEREZ Cia Ltda.  
P. O. B. 3415  
Branches - Ave. 7a Central 26 - 109  
Ave. « B » No. 56 - PANAMA R. P.

PARAGUAY - NICOLAS PORZIO  
Calle Palmas 295 - ASUNCION.

PERSIAN GULF  
BARRAK ABDULMOHSIN ALAQIL & CO.  
KUWAIT (Arabia).

PERU - NIZZOLA & CO.  
Carabaya 801 - Casilla 3896 - LIMA.

PHILIPPINES  
NATIONAL MERCHANDISING CO.  
3111, Nagtahan Street  
SAN MIGUEL - MANILA

PORTUGAL  
MOTO LAMBRETTA PORTUGUESA Ltd.  
Rua 1 - De Dezembro 82,2 (rosso)  
LISBOA.

PORTUGUESE GUINEA  
SOCIEDADE COMERCIAL  
ULTRAMARINA - Caixa Postal 23  
BISSAU.

PUERTO RICO  
MARTORANI MOTORS INC.  
Av. Ponce de Leon, 1402  
SANTURCE.

RHODESIA - MILLAR ROAN & CO. Ltd.  
13th Avenue - Rhodes Street  
BULAWAYO.

SAUDI ARABIA  
SAMI KUTBI & BROTHERS  
P. O. Box 247 - JEDDAH.

SENEGAL-AURITANIE - S. A. FENWICK  
4, Av. Gambetta - DAKAR.

SIERRA LEONE  
THE UNITED AFRICA CO. Ltd.  
FREETOWN.

SOUTH AFRICA  
H. R. HENDY & LEONTSINIS Ltd.  
P. O. B. 7577 - JOHANNESBURG.

SOUTH WEST AFRICA  
M+Z MOTOR & ENG Ltd.  
P. O. Box 192 - WINDHOEK.

SPAIN  
LAMBRETTA LOCOMOCIONES S. A.  
Apartada 137 - EIBAR.

SUDAN (Fr.) - MAUREL FRERES  
BAMAQO - B. P. 154.

SWEDEN - BIL & TRUCK  
Odinsplatsen, 9 - GOTEBORG.

SWITZERLAND - CILO S. A.  
6, Petil Rocher - LAUSANNE.

SYRIA - ESTEFANE & Cie.  
B. P. 415 - DAMAS.

TAHITI - ETS. MARCEL LASSERRE  
PAPEETE - Av. Clémenceau.

TANGANYKA - See: British East Africa.

TANGERI - See: Marokko.

TCHAD - SOCIETE COMMERCIALE DU  
KOUILOU NIARI  
FORT LAAMY.

THAILAND  
BERLI, JUCKER & Co.  
1136 New Road - BANGKOK.

TOGO (A.O.F.) - UNITED AFRICA CO.  
LOME.

TUNISIE - LA TUNISIENNE AUTOMOBILE  
TUNIS - 8, rue de Grèce.

TURKEY - F.LLI ALIOTTI  
B. P. 362 - IZMIR.

UGANDA - See: British East Africa.

UNITED STATES OF AMERICA  
INNOCENTI CORPORATION  
Lambretta Division  
43 West 61 st. Street  
NEW YORK, 23 N. Y.  
Western States Parts  
Distributors:  
HARRISON - RENO  
201 N. Sycamore Street  
SANTA ANA, California.

URUGUAY  
SIAM TORCUATO DI TELLA S. A.  
Av. de Uruguay, 1123 - MONTEVIDEO.

VENEZUELA - IVENSA INTERNACIONAL  
VENEZOLANA  
Corrales del Este - Apartado 4393  
CARACAS.

VIETNAM - VINACO  
35 Rue Phu-Kiét - SAIGON.

YEMEN - PAUL RIES & SONS Ltd.  
HODEIDAH.

YUGOSLAVIA - JADRAN  
P. O. B. 917 - BELGRADO.

ZANZIBAR - See: British East Africa.

## ITALY

AGRIGENTO - Dr. SALVATORE CAPIZZI  
Via Imera 19, tel. 19-36.

ALBA (Cuneo) - F.LLI CAPRA  
Corso M. Coppins 5, tel. 25.07.

ANCONA - CAV. ALBERTO BÉTTITONI  
Via Giannelli 1-bis, tel. 24.947.

AOSTA - VITTORIO APOSTOLO  
Via Xavier de Maistre 20, tel. 21-13.

AREZZO - LUIGI AGNELLI  
Via Garibaldi 109, tel. 25-24.

ASCOLI PICENO - « ASCO » ASCOLANA  
SCOOTER S.r.l.  
Via della Repubblica, tel. 35-77.

ASTI - COMETA S.r.l.  
Corso Cavour 29, tel. 50-167.

AVELLINO - GIUSEPPE BELLUCCI  
Viale Gramsci 8, tel. 16-41.

AVEZZANO (Roma) - DE NICOLA NINO  
Via C. Corradini 156, tel. 117.

BARI - Dr. R. PIERI & V. OMATI  
Via De Giosa 10-12, tel. 13-494.

BARI - CALABRESE GIUSEPPE  
Via Piccini, 113.

BARLETTA (Bari) - NUNZIO DI LEO  
P.zza Tramvia, tel. 10-67.

BASSANO DEL GRAPPA (Vicenza) -  
BERTI SERGIO & MARIO  
Via Vercl 27, tel. 23-532.

BELLUNO - VITTORIO D'INCA LEVIS  
Via S. Pietro 3, tel. 41-88.

BENEVENTO - METALMECCANICA SAN-  
NITA S.r.l.  
Piazza Biscolati 13, tel. 15-54

BERGAMO - MASSIMO MASSERINI  
Via A. Maj 14, tel. 23-896.

BIELLA - S.A.S. MARCELLO RAMELLA & C.  
Viale Macallè 31, tel. 23-268.

BOLOGNA - C.I.S.A. S.r.l.  
Via Ugo Bassi 31, tel. 31-432.

BOLZANO - GARAGE TOURING  
di MARIO KETTMEIR  
Via Cavour 23, tel. 25-353.

BORGOMANERO (Novara) - SAVOINI  
GIUSEPPE & FIGLI  
Corso Sempione 35, tel. 81-494.

BRA (Cuneo) - F.LLI MONCHIERO  
Via Vittorio, 137

BRESCIA - NELLO BRINIS & C.  
C.so Magenta 39, tel. 27-260.

BRESCIA - ARTURO PETACCIA  
Via Dante 4, tel. 26-361.

BRINDISI - OC.RA  
Piazza Cairoli 44, tel. 11-82.

BUSTO ARSIZIO - MARA MARIO  
Via Galilei 2, tel. 34-321.

CAGLIARI - IN.CO.SA. S.r.l.  
Via Dante 105, tel. 42-92.

CALTAGIRONE - GIACOMO GATTUSO  
Via G. Arcoleb, 19, tel. 14-31.

CALTANISSETTA - COSENTINO E GRI-  
MALDI - Via Palmintelli 52.

CAMPASSO - NICOLA MUCCIACCIA  
C.so Mazzini 31, tel. 41-09.

CARPI (Modena) - COMMISSIONARIA  
LAMBRETTA CARPI S.r.l.  
Via Ciro Menotti 2, tel. 61-787.

CARRARA (Apuania) - BATTISTA PIERI  
Via Roma 36, tel. 29-84.

CASALE MONFERRATO (Alessandria) -  
Ditta CURINO TERESIO  
Via A. Sobrero 11, tel. 43-24.

CASERTA - AUTOMOTO CASERTANA  
Via C. Battisti 38-40, tel. 21-784.

CASSINO (Frosinone) - F.LLI CORVI  
Via Roma 174.

CASTELLAMARE DI STABIA (Napoli) -  
GARAGE OMNIA di F. INGENITO  
Piazza Circumvesuviana, tel. 16-63.

CATANIA - S.V.A.M.  
Via Crispi 199-201, tel. 25-334.

CATANIA - C.A.L.B.I. S.p.A.  
Via Pacini, Palazzo I.N.A., tel. 17-116

CATANZARO - EUGENIO CHIODO  
Corso Mazzini 5, tel. 17-27

CECINA (Livorno) - LUIGI VENTURI  
C.so Matteotti 96, tel. 73-030

CESENA (Forli) - ANTONIO GIACOMO-  
NI & F. S.p.A.  
Via C. Battisti 1, tel. 21-332

**SALERNO** - Comm. Rag. D'AVOSSA AN-DREA  
Corso Garibaldi 166/168, tel. 33-00.

**SALO' (Brescia)** - FRANCESCHI ATTILIO  
Via S. Carlo 19, tel. 24-31.

**SALUZZO (Cuneo)** - MIOLANO FRAN-CESCO  
Via Torino 82, tel. 23-56.

**SAN MARINO** - A. RIGHI  
Piazza del Mercato 129, tel. 168.  
**BORGO MAGGIORE**

**SANREMO (Imperia)** - LUIGI BRUZZONE  
C.so Garibaldi 2, tel. 54-77.

**SASSARI** - IN.CO.SA.  
Via dei Mille (ang. Via Murani)  
tel. 21-56.

**SAVONA** - CICLI PORASSO  
Corso Italia 19-21, tel. 21-926.

**SESTRI LEVANTE (Genova)**  
O.M.E.R. - AGROFOGLIO & RAMPONE  
Via Nazionale 119, tel. 41-270.

**SIENA** - CAMILLO VANNOCCI  
Via Pieve 4, tel. 20-705.

**SIRACUSA** - VINCENZO D'AMICO URSO  
Via dei Miracoli 39, tel. 19-58.

**SONDRIO** - OTTORINO RUFFINI  
Via Trento 6-c, tel. 29-65.

**SPOLETO (Perugia)** - F. VANTAGGIOLI  
Via Trento Trieste 18, tel. 51-45.

**SULMONA (L'Aquila)**  
ALBERTO SACCHETTA  
Via Occidentale 111, tel. 21-73.

**TARANTO** - GERARDO BARDICCHIA  
P. Massari 1, tel. 15-85.

**TERAMO** - F.lli DI BONAVENTURA  
Via Delfico 61, tel. 52-85.

**TERNI** - GIUSEPPE BELLI  
Via Lungonera 55, tel. 29-191.

**TIVOLI (Roma)** - BRUNO PACIFICI  
Viale P. Tomei 21, tel. 30-32.

**TORINO** - DARIO VICO  
Via Filadelfia 51, tel. 524.293.

**TORTONA (Alessandria)**  
ROLANDI RICCARDO  
Via Circonvallazione 145, tel. 81-557.

**TRAPANI** - ATTILIO AMODEO  
Via Virgilio 16, tel. 15-51.

**TRENTO** - DITTA MARTINO AICHNER  
Via Brennero 102.

**TREVIGLIO (Bergamo)** - O.R.V.A.M.  
Via C. Battisti 5/c, tel. 21-91.

**TREVISO** - S.G.A.M. di A. COMIRATO  
Via S. Nicolò 11, tel. 22-712.

**TRIESTE** - FILOTecnica GIULIANA S.r.l.  
Via Carducci 7, tel. 23-279.

**UDINE** - NELLO BRINIS & C.  
Via Pascolle 43, tel. 27-07.

**UDINE** - AUTOSCOOTER  
di OTTONE PIUSI  
Via Treppo 28/a, tel. 55-877.

**VARESE** - C. F. BUZIO  
Via Orrigoni 2, tel. 25-673.

**VASTO (Chieti)** - SAVERIO BACCALA  
C.so Garibaldi 123, tel. 126.

**VELLETRI (Roma)** - GIUSEPPE RONSINI  
Viale Roma 14, tel. 96-465.

**VENEZIA - MESTRE**  
GIAMPIETRO TUROLLA  
Via Pieve 145-147, tel. 56-094.

**VERBANIA** - VERBANIA MOTOR S.r.l.  
C.so Mameli 55, tel. 41-042.

**VERCELLI** - CASA DELLA MOTO  
di FABIO FAVANTI  
Corso Prestinari 26, tel. 34-68.

**VERONA** - SO.VE.MO.  
Viale Cittadella 18, tel. 34-580.

**VERONA** - S.R.A.M.  
Via Nizza 1, tel. 38-383.

**VIAREGGIO (Lucca)** - SEM DE RANIERI  
Via Garibaldi 6, tel. 24-25.

**VICENZA** - LEONE CHIARELLO  
Porta Padova 82, tel. 23-646.

**VIGEVANO (Pavia)** - ABELE CERASTICO  
Via Ceresotti 5, tel. 25-76.

**VITERBO** - MOTOSPORT di P. MARINELLI  
Via Orologio Vecchio 22, tel. 26-40.

**VITTORIO VENETO (Treviso)**  
MARCHIO' GIUSEPPE  
Via Casoni 5, tel. 32-33.

**VOGHERA (Pavia)** - S. MONTAGNA & C.  
Via Don Minzoni 10, tel. 52-82.

*In your own interest  
ask and accept*

**ONLY ORIGINAL SPARE PARTS**

# Lambretta

The **INNOCENTI** Co. supplies,  
through its agents,  
original spare parts  
in sealed packing  
or with a guarantee band



scooterhelp.com